

# Edinburgh Sensors

## Guardian NGDC- Infrared Gas Monitor User Guide



## **Copyrights**

Copyright © 2013, © 2015, © 2016 Edinburgh Instruments Ltd. All rights reserved.

No part of this publication may be reproduced, stored in a retrieval system, or transmitted in any form or any means electronic or mechanical, including photocopying and recording for any purpose other than the purchaser's personal use without written permission.

The product described in this manual is subject to continuous development and, while every effort has been taken to make sure that the information given is correct, Edinburgh Instruments Ltd cannot accept any liability for errors and omissions or their consequences.

# Guardian NGDC – Infrared Gas Monitor

Issue No. 1 - v06/16  
For systems delivered after  
May 2016  
Firmware Version 1.17 or Later

© Edinburgh Instruments Ltd  
2 Bain Square, Kirkton Campus, Livingston, EH54 7DQ UK  
Phone: +44 (0) 1506 425300 Fax: +44 (0) 1506 425320  
email: [gassensor@edinst.com](mailto:gassensor@edinst.com)  
<http://www.edinst.com>

---

## **Warning!**

**This Manual outlines the function and use of the Guardian NG gas monitor which may be used as described here and for no other purpose.**

**The Guardian NGDC is not suitable for the detection of flammable gases or mixtures of gases that are flammable or may become flammable if mixed with Air. If you are unsure about the properties of the sample gas, seek professional advice regarding the suitability of the Guardian NG for your application.**

**The Guardian NGDC's sampling system is NOT hermetically sealed and will leak small quantities of the sample gas in to its enclosure. Gases such as carbon monoxide and hydrogen sulphide are extremely **TOXIC** and so potentially harmful levels may build up inside the enclosure. The exhaust from the Guardian NG is potentially toxic and should be disposed of safely. If you are unsure of the risks seek professional advice regarding your intended use.**

---

<b>1</b>	<b>INTRODUCTION</b> .....	<b>1</b>
<b>2</b>	<b>INSTALLATION</b> .....	<b>2</b>
2.1	MECHANICAL INSTALLATION .....	2
2.2	ELECTRICAL INSTALLATION .....	2
2.3	GAS CONNECTION.....	4
<b>3</b>	<b>OPERATION</b> .....	<b>5</b>
3.1	FRONT PANEL DISPLAY MENU.....	6
3.2	<b>ANALOGUE OUTPUT</b> .....	16
3.3	POWER-ON SELF TEST SEQUENCE.....	17
3.4	RELAY OUTPUTS .....	18
3.5	DC POWER SUPPLY .....	18
<b>4</b>	<b>MAINTENANCE &amp; SERVICE</b> .....	<b>19</b>
4.1	FILTER REPLACEMENT .....	20
4.2	OPENING THE GUARDIAN NGDC.....	20
4.3	REMOVING THE MOUNTING PLATE .....	21
4.4	FUSE REPLACEMENT .....	22
4.5	PUMP REPLACEMENT .....	22
4.6	CLEANING .....	22
<b>5</b>	<b>CALIBRATION</b> .....	<b>23</b>
5.1	CALIBRATION GAS ACCURACY.....	23
5.2	CONNECTING CALIBRATION GAS TO THE GUARDIAN NGDC .....	23
5.3	EFFECTS OF PRESSURE ON CALIBRATION .....	24
5.4	CALIBRATION CHECKING PROCEDURE.....	25
5.5	CALIBRATION PROCEDURE (SEE ALSO 3.1.1) .....	25
<b>6</b>	<b>TROUBLE SHOOTING</b> .....	<b>27</b>
6.1	ERRORS & FAULT INDICATIONS FROM THE FIRMWARE .....	27
<b>7</b>	<b>SAFETY &amp; SYSTEM INTEGRITY</b> .....	<b>29</b>
7.1	<b>TOXIC GASES</b> .....	30
<b>8</b>	<b>SPECIFICATION</b> .....	<b>31</b>
<b>9</b>	<b>GLOSSARY</b> .....	<b>32</b>
<b>10</b>	<b>INDEX</b> .....	<b>33</b>
<b>11</b>	<b>ACCESSORIES AND SPARE PARTS</b> .....	<b>34</b>
<b>12</b>	<b>WARRANTY</b> .....	<b>35</b>
<b>13</b>	<b>CE MARK DETAILS</b> .....	<b>36</b>
<b>14</b>	<b>DOCUMENT CHANGE HISTORY</b> .....	<b>37</b>
	<b>APPENDIX A</b> .....	<b>38</b>
	<b>APPENDIX B</b> .....	<b>39</b>

# Contents

## List of Figures

Figure 1: Power Connection and Current Output Terminals.....	3
Figure 2: Alarm and Fault Relay Terminals .....	4
Figure 3: Guardian NGDC Front Panel.....	5
Figure 4: VALUE mode screenshot .....	6
Figure 5: SETUP mode Screenshot.....	7
Figure 6: SETUP mode with High Alarm selected Screenshot. <b>Error! Bookmark not defined.</b>	
Figure 7: High Alarm Enable/Disable .....	8
Figure 8: High Alarm Set Value screen.....	9
Figure 9: LCD settings screen .....	11
Figure 10: Set password screen .....	12
Figure 11: Resolution Screen .....	13
Figure 12: Graph Screen.....	14
Figure 13: Graph settings menu. ....	15
Figure 14: Analogue Output Terminals. ....	16
Figure 15: Bit switch .....	17
Figure 16: Guardian NGDC Internal View.....	19
Figure 17: Connecting the calibration gas to the Guardian NGDC .....	24

## List of Tables

Table 3.1: measurement ranges .....	13
Table 3.2: Analogue output options .....	16
Table 3.3: Guardian NGDC self-test and warm-up sequence. ....	17
Table 3.4: Relay contact switching loads.....	18
Table 3.5: Voltage limits.....	18
Table 4.1: Fuse details .....	22
Table 6.1: Troubleshooting, problems and solutions. ....	28
Table 7.1 Gas Hazards .....	29
Table 7.2: Gas toxicity.....	30
Table 8.1: Specifications .....	31

## List of Procedures

<i>Procedure 1: Positioning the monitor.....</i>	<i>2</i>
<i>Procedure 2: Setting the High Gas Concentration Alarm - Summary .....</i>	<i>9</i>
<i>Procedure 3: Setting the Idle Polarity .....</i>	<i>9</i>
<i>Procedure 4: Setting the low gas concentration alarm. ....</i>	<i>10</i>
<i>Procedure 5: Setting the LCD contrast. ....</i>	<i>11</i>
<i>Procedure 6: Setting the password.....</i>	<i>12</i>
<i>Procedure 7: Setting the Screen Resolution.....</i>	<i>13</i>
<i>Procedure 8: Returning the unit to factory default settings.....</i>	<i>14</i>
<i>Procedure 9: Replacing the filter.....</i>	<i>20</i>
<i>Procedure 10: Opening the Guardian NGDC enclosure:.....</i>	<i>20</i>
<i>Procedure 11: Removing the mounting plate.....</i>	<i>21</i>
<i>Procedure 12: Replacing the fuse.....</i>	<i>22</i>
<i>Procedure 13: Replacing the pump .....</i>	<i>22</i>
<i>Procedure 14: Cleaning the monitor .....</i>	<i>22</i>
<i>Procedure 15: Connecting calibration gas to the Guardian NGDC. ....</i>	<i>23</i>
<i>Procedure 16: Checking the calibration:.....</i>	<i>25</i>
<i>Procedure 17: Calibrating the Guardian NGDC.....</i>	<i>26</i>

## 1 Introduction

The Guardian NGDC wall mounted monitor provides continuous analysis of gas concentration levels at atmospheric pressure. It can sample the gas either next to the monitor or from sampling points up to thirty metres away using the integral sampling system. It features comprehensive output, alarm and fault indications via the on-board microcontroller. The Guardian NGDC is based on dual wavelength non-dispersive infrared (NDIR) technology. It offers reliable, high performance operation while requiring low maintenance.

Main features:

- Display (LCD)
- Current analogue output 4-20mA or 0-20mA linear, user selectable
- 2 independent alarm/set points with volt free relay contacts
- Internal self test with volt free fault relay contacts
- Audible and visual alarm and fault indication
- Internal pump
- Low flow sensor
- Enclosure protection to IP54
- Easily replaceable particle filter
- Output options configured by user from the front panel

## 2 Installation

The Guardian NGDC should be mounted on a vertical surface using three M4 machine screws or No. 8 wood screws.

When choosing a site, ensure there is plenty of space around the monitor, especially at the base. This is to allow the terminal compartment cover to be opened and enable all cables and tubing to be connected.

### 2.1 Mechanical Installation

#### *Procedure 1: Positioning the monitor*

- 1 i) Select a suitable location for the monitor, fit the top centre screw and hang the unit from the central fitting at the top.
- 1 ii) Remove the terminal compartment cover to reveal the slotted fixing holes and mark suitable positions for the two securing screws.
- 1 iii) Remove the Guardian NGDC and drill holes for the two securing screws.
- 1 iv) Hang the Guardian NGDC back on the central screw and secure it through the slotted holes.

### 2.2 Electrical Installation

The following precautions must be observed in the installation of this equipment:

- Any required electrical installation should only be performed by a suitably qualified electrical engineer.
- The cable glands provide both cable restraint and sealing. They should only be used with circular cables in the range 8 to 10 mm diameter. Check that the glands are tight after installation and that the cables are restrained.

A cable gland is provided at the left hand side of the terminal compartment for the DC supply. The supply voltage must be in the range 18 – 30 VDC - see rating plate on the side of the case. The power terminal block connections are marked +24 V for the positive connection, 0 V for the negative connection and GND for the ground connection. (See Figure 1 below)



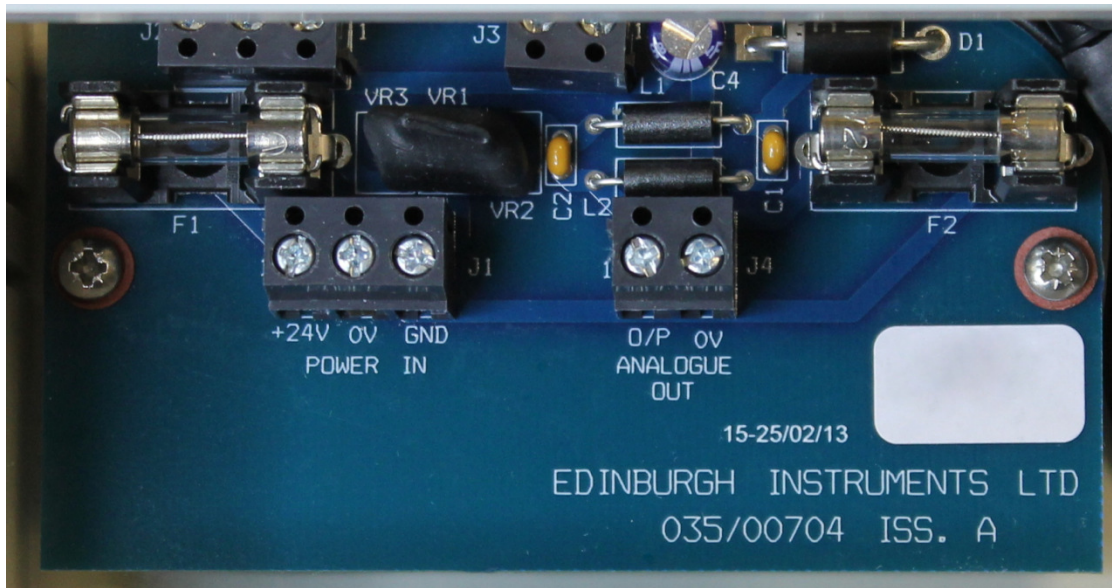

Figure 1: Power Connection and Current Output Terminals

Connections from the relays to remote equipment are made from connections at the right hand side of the terminal compartment, a cable gland is provided for these outputs. Should mains voltages or other hazardous voltages be applied to the relays, the wiring should be separated from any low voltage wiring to the analogue output. These should also use a separate cable gland. Connections should not be made between a mains terminal relay connection and any terminals within the terminal compartment.

### CAUTION

**Under no circumstances should mains voltages be applied to the analogue output or power terminals as this will both damage the equipment and cause a safety hazard.**

There are three relay outputs available on the Guardian NGDC labelled, from left to right, Fault, Alarm Low and Alarm High. Each relay output terminal block has three terminals which are from left to right Normally Open, Common and Normally Closed, labelled T2, P and T1 in Figure 2 below. A fault is indicated when FAULT relay is de-energised (disconnected from the power source), causing the P terminal to be connected to the T1 terminal. For alarm relay indications see section 3 Operation.

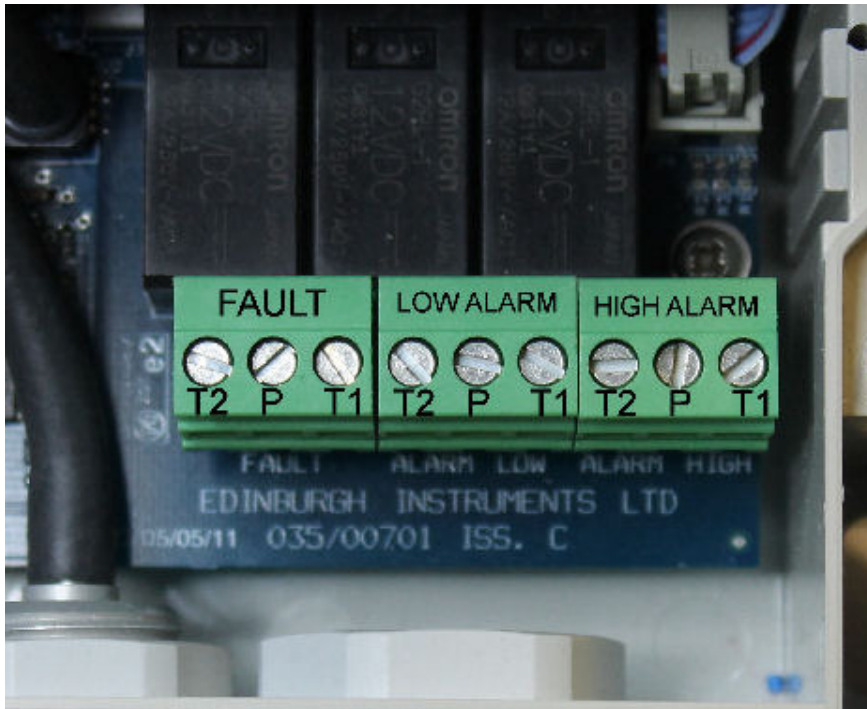

Figure 2: Alarm and Fault Relay Terminals

## 2.3 Gas Connection

Remote sampling may be performed by connecting up to thirty metres of 5 mm bore tubing to the gas inlet. The monitor application and the environmental conditions in which the monitor is to be operated should be assessed, so that a compatible tubing material can be chosen. For most applications Neoprene, PVC or nylon are suitable tubing materials. Natural rubber is not recommended due to its tendency to perish. Silicone rubber tubing is not suitable. It readily absorbs and releases gas, as a result it exhibits a 'memory' effect which leads to false readings. There is a small 'memory' effect with all plastic tubing; this is not normally a problem. However, for demanding applications involving longer lengths of external tubing, copper or other metal tubing should be considered.

If condensation is likely to occur in the sample line, an external water trap should be fitted and regularly emptied. Condensation will be a problem in situations where the sample line is cooled below the temperature of the sampling point. This may occur if the tubing is cooled by draughts, is external to the building where the sample is taken or passes through a cold area within a building.

Gas vented from the monitor can be released into its surroundings unless safety considerations require that the gas be vented elsewhere. This can be achieved by attaching 5 mm bore tubing to the outlet nozzle. The venting gas system should ensure minimal back pressure. Any increase in the pressure within the sensor head may lead to a reading error or flow alarm if the internal pressure exceeds ~1150 hPa absolute.

## 3 Operation

The operation of the Guardian NGDC is described in terms of the outputs, the inputs and the controls. The outputs are; display, LED indicators, analogue output, alarm and fault relays: inputs are; gas sensor, flow sensor, fault detection system and the controls are; menu controlled navigation keys, calibration adjustment switches and the menu options.

The function of the equipment is controlled by the menu system which allows the user to select the various output options.

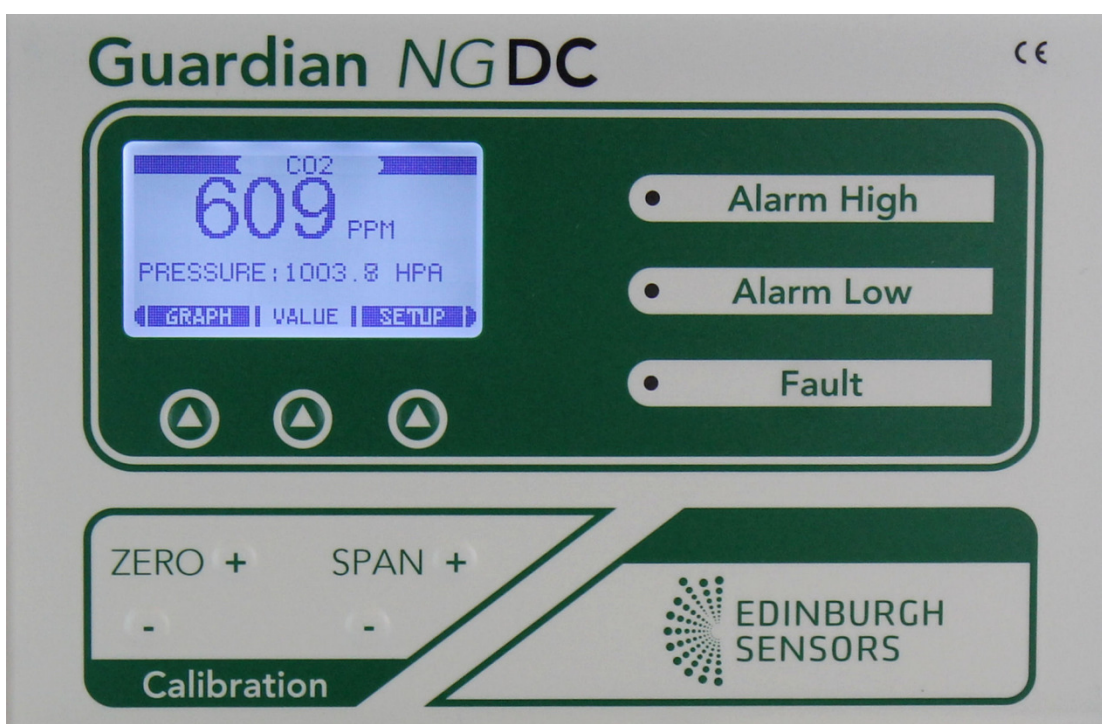



Figure 3: Guardian NGDC Front Panel

The front panel of the Guardian NGDC shown in Figure 3 above consists of a display window, three navigation buttons  four calibration adjustment buttons, two alarm LEDs and a fault LED.

The functions of the navigation buttons  are displayed on the bottom line of the graphic display. These labels will change depending on where the user is on the navigation tree. A guide to the navigation of the menu system is given below.

### 3.1 Front Panel Display Menu

The default mode after the start-up is the VALUE mode. It displays the name or chemical formula of the gas whose concentration is being indicated, the indicated concentration, and the pressure in the sampling cell, (See Figure 4 below)

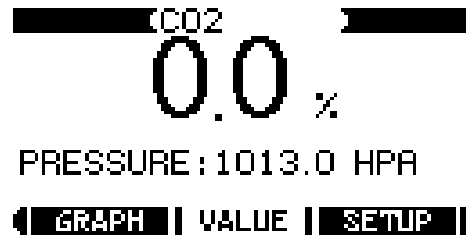

Figure 4: VALUE mode screenshot

In VALUE mode the display shows the following options are available for the navigation buttons:

- Graph
- Value
- Setup

If the navigation button beneath any of these options is pressed further options are revealed. These can be accessed through the menu system described below. If the navigation button on the right is pressed, when the display is as shown in Figure 4, the SETUP menu will be revealed and so is referred to as the SETUP button.

**Note:** Low range instruments will show the concentration in parts per million (ppm) and not as a percentage.

#### 3.1.1 VALUE Mode

When in VALUE Mode pressing the VALUE button, the central navigation button, will open the calibration mode. The four calibration buttons: ZERO +, -, and SPAN +, -, may then be used to adjust the calibration using the procedure described in *Procedure 17: Calibrating the Guardian NGDC*.

### 3.1.2 SETUP mode

When in VALUE mode pressing the right most of the three navigation buttons will open the SETUP mode. In firmware versions before V1.17 the SETUP mode has six options as shown in Figure 5 below.

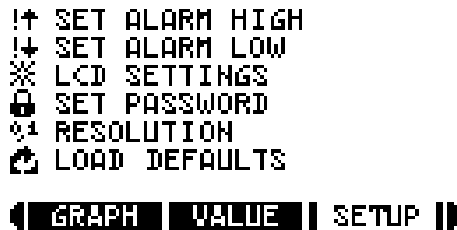

Figure 5: SETUP mode Screenshot

In firmware versions after V1.17 the SETUP mode has five options as shown in Figure 6 below.

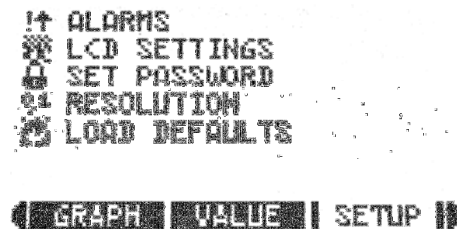

Figure 6: SETUP mode Screenshot (Firmware 1.17)

Pressing the right most of the three navigation buttons still labelled SETUP, you access the menu, and this allows you to scroll down through the options using the navigation button beneath the down arrow **↓** button.

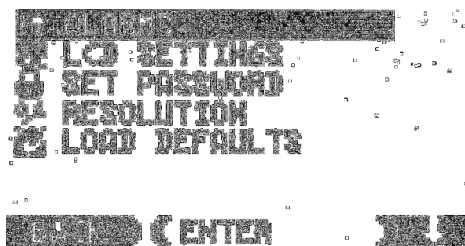

Figure 7: SETUP mode with Alarms selected Screenshot.

Pressing the middle of the three navigation buttons labelled ENTER will display the ALARMS menu as shown in Figure 8 below.



Figure 8 ALARMS menu

The BACK button takes you back to the setup menu, the ENTER (middle button) will display the available options menu for the selected setting, and the down arrow **⏴** allows you to scroll down the selected settings.

The functions available as options in the SETUP and ALARMS menus are described below:

- SET ALARM HIGH: This allows you to set the value at which the high gas concentration alarm is activated. See 3.1.4 for more details.
- SET ALARM LOW: This allows you to set the value at which the low gas concentration alarm is activated. See 3.1.6 for more details.
- FLOW SENSOR: This allows you to enable or disable the low flow alarm. See 3.1.7
- LCD SETTINGS: This allows you to adjust the contrast of the display. See 3.1.8 for more details.
- SET PASSWORD: This menu allows the enabling/disabling of the password and allows the password to be changed.
- LOAD DEFAULTS. Loads the default values for the graphic display. See *Procedure 8* for more details.

### 3.1.3 Set High Alarm Menu

To set the high alarm, you need to Highlight the SET ALARM HIGH line in the setup menu and press ENTER. This will take you to the SET ALARM HIGH menu shown below.

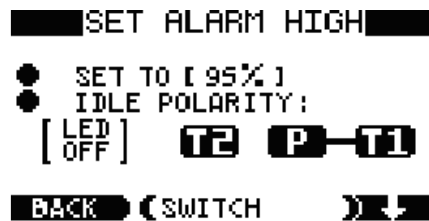

Figure 9: High Alarm Enable/Disable

The alarm can be set to be active above or below the set point. When the IDLE POLARITY is set to LED OFF and the gas concentration is below the set point, the LED and relay are unpowered (P connected to T1, as shown in the graphic display). When the gas reading exceeds the set point, the LED is lit and relay is powered (P connected to T2). The bar connecting T1 to P in the graphic display above indicates the relay connection in the non-alarmed state.

### 3.1.4 Set High Alarm Value screen

The first menu option allows you to set the value of the high alarm. The set point is given in percent of the span of the unit. To set the value, highlight the numerical value box and press EDIT. Figure 10 below shows the display with the value box selected for setting.

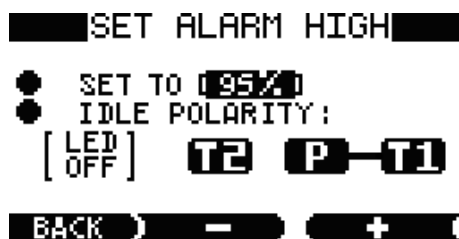

Figure 10: High Alarm Set Value screen

*Procedure 2: Setting the High Gas Concentration Alarm - Summary*

- 2i) While in the VALUE mode (shown in Figure 4, the default mode after switch on) press the right-hand navigator button – the SETUP button.
- 2ii) This brings up the menu as shown in Figure 5
- 2iii) Press the right-hand navigator button to access the menu (Figure 7)
- 2iv) Use the right-hand button labelled with an arrow to scroll through the menu. Highlight “SET ALARM HIGH” then press the central ENTER button. This brings up the set alarm high menu (shown in Figure 9)
- 2v) To set the value at which the alarm is activated, use the right-hand navigator button to highlight the SET TO [## %] option then press the central ENTER button.
- 2vi) The central and right-hand + and – buttons now enable the limit to be changed in 5% steps (This display screen is shown in Figure 10).

### 3.1.5 Set Idle Polarity Option

The Set Alarm High IDLE POLARITY option sets the alarm conditions of the High Alarm relay and front panel High Alarm LED. It enables the user to choose whether the Alarm LED and Relay are activated (powered) above the set point or activated below the set point. If the IDLE POLARITY is set to LED OFF and the indicated concentration is less than the set point, the High Alarm LED will be off and the relay will be unpowered. P is connected to T1.

If it is set to LED ON, the High Alarm LED will be on when the indicated concentration is less than the set point and terminal T2 will be connected to the common terminal P. The non-alarm state of the LED and Relay is indicated by the bar connecting either T1 or T2 to P (as shown in Figure 10).

*Procedure 3: Setting the Idle Polarity*

- 3i) While in the VALUE mode (shown in Figure 4, the default mode after switch on) press the right-hand navigator button – the SETUP button.
- 3ii) This brings up the menu as shown in Figure 5.
- 3iii) Press the right-hand navigator button to access the menu (Figure 7).
- 3iv) Use the right-hand button labelled with an arrow to scroll through the menu. Highlight either SET ALARM HIGH or SET ALARM LOW (depending on whether you want to change the idle polarity for the high or low gas concentration alarm) then press the central ENTER button. This brings up the set alarm menu.
- 3v) Use the right-hand navigator button to select IDLE POLARITY in the menu then use the central SWITCH button to change the polarity.

### 3.1.6 Set Low Alarm Menu

To set the options for the low alarm select SET ALARM LOW from the settings menu then proceed as for setting the high alarm described above.

**Note:** - The default “Idle Polarity” setting is “LED ON” for both high and low alarms so that both alarms are activated when the indicated concentration drops below the alarm set value. Both alarms are in the T1 connected to P condition when the unit is de-powered.

*Procedure 4: Setting the low gas concentration alarm.*

- 4i) While in the VALUE mode (shown in Figure 4, the default mode after switch on press the right-hand navigator button – the SETUP button.
- 4ii) This brings up the menu as shown in Figure 5
- 4iii) Press the right-hand navigator button to access the menu (Figure 7
- 4iv) Use the right-hand button labelled with an arrow to scroll through the menu. Highlight SET ALARM LOW then press the central ENTER button. This brings up the set alarm low menu (shown in Figure 9)
- 4v) To set the value at which the alarm is activated, use the right-hand navigator button to highlight the SET TO [##%] option then press the central EDIT button.
- 4vi) The central and right-hand + and – buttons now enable the limit to be changed in 5% steps (This display screen is shown in Figure 10).
- 4vii) In order to set the alarm such that it is activated when the gas concentration is below the low set point it is necessary to change the idle polarity see 3.1.5.

### 3.1.7 Flow Sensor (V1.17 Firmware and above only)

To set the options for the FLOW SENSOR alarm proceed as for setting the high alarm described above but select FLOW SENSOR from the ALARMS settings menu then proceed as described below.

The FLOW SENSOR menu screen is used to enable or disable the flow alarm as shown in Figure 11 below.

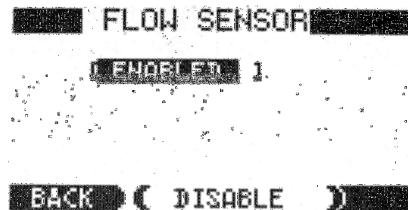

Figure 11 FLOW SENSOR screen

The FLOW SENSOR has only two settings ENABLED and DISABLED and the setting is toggled by pressing the central navigation button when in the FLOW SENSOR menu.

When the FLOW SENSOR is set to disabled a low flow will NOT generate a flow fault or a fault alarm.

**CAUTION**

**Setting the FLOW SENSOR to DISABLED will prevent low flow from activating a flow fault or a fault alarm**



### 3.1.8 LCD settings screen

The LCD SETTINGS menu is used to adjust LCD display contrast. To open the LCD SETTINGS menu highlight the LCD SETTINGS option in the SETUP menu (see Figure 5) and select by pressing the ENTER button. Figure 12 below shows the display with the LCD contrast value selected for setting. The + and – buttons allow value of the display contrast to be adjusted for best visibility.

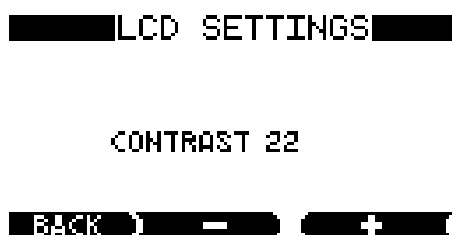

Figure 12: LCD settings screen

*Procedure 5: Setting the LCD contrast.*

- 5i) While in the VALUE mode (shown in Figure 4, the default mode after switch on press the right-hand navigator button – the SETUP button.
- 5ii) This brings up the menu as shown in Figure 5.
- 5iii) Press the right-hand navigator button to access the menu.
- 5iv) Use the right-hand button labelled with an arrow to scroll through the menu. Highlight LCD SETTINGS then press the central ENTER button. This brings up the LCD SETTINGS SCREEN, shown in Figure 12.
- 5v) Use the central and right-hand buttons labelled + and – to adjust the contrast.

**CAUTION**

**Setting the contrast too far from its original value can make the display impossible to read. Use this functionality with care. The factory default value is “14”.**

### 3.1.9 Set Password screen

The Guardian NGDC has an optional password facility to prevent unauthorized adjustments being made to the way the monitor is set up and calibrated.

The PASSWORD menu allows a password to be set or changed.

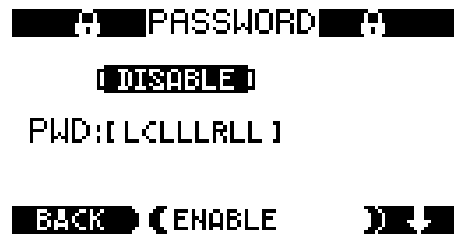



Figure 13: Set password screen

The password is made of three letters: L, C & R. They correspond to the positions of the three navigation buttons  under the display, left (L), the centre (C) and the right key (R). The password is 8 characters long and once set it will need to be entered before access to the protected menu items will be enabled again. Once the password is enabled the keypad will lock after about 12 seconds of no activity in any of the top level menu screens (GRAPH, VALUE or SETUP). To unlock a protected setting, navigate to the item using the three buttons , and enter the 8 character password when requested.

*Procedure 6: Setting the password*

- 6i) While in the VALUE mode (shown in Figure 4, the default mode after switch on) press the right-hand navigator button – the SETUP button.
- 6ii) This brings up the menu as shown in Figure 5.
- 6iii) Press the right-hand navigator button to access the menu.
- 6iv) Use the right-hand button labelled with an arrow to scroll through the menu. Highlight SET PASSWORD then press the central ENTER button. This brings up the password screen, shown in Figure 13.
- 6v) Use the right-hand button to highlight the password (PWD).
- 6vi) Press the central MODIFY button to change the password. The password is made up of 3 letters L, C, R; standing for left, centre and right and referring to the three navigation buttons.
- 6vii) To enable or disable the password highlight the top menu option which shows either ENABLED or DISABLED and press the central button (DISABLE or ENABLE). Once enabled, the password will take effect after 12 seconds of inactivity in any of the top level menu screens, GRAPH, VALUE or SETUP.

### 3.1.10 Set Display Resolution screen

For ranges up to 5000 ppm the concentration is displayed in parts per million (ppm). For ranges 1% and above, the concentration is displayed as a percentage, as shown in Table 3.1.

Measurement Ranges
0 - 2000 ppm
0 - 3000 ppm
0 - 5000 ppm
0-1 %
0-3 %
0-10 %
0-30 %
0-100 %

Table 3.1: measurement ranges

The displayed resolution may be adjusted to suit different applications. From the SETUP menu (see Figure 7) using the down arrow button  select the RESOLUTION option and press the enter button. The display will change to look like the example in Figure 14:

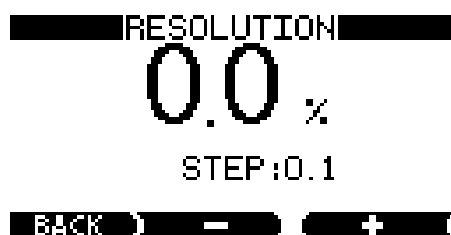

Figure 14: Resolution Screen

**Note:** The accuracy of the gas monitor does not change, only the display resolution. Pressing the BACK button returns the display to the SETUP menu.

#### Procedure 7: Setting the Screen Resolution

- 7i) While in the VALUE mode (shown in Figure 4, the default mode after switch on) press the right-hand navigator button – the SETUP button.
- 7ii) This brings up the menu as shown in Figure 5.
- 7iii) Press the right-hand navigator button to access the menu.
- 7iv) Use the right-hand button labelled with an arrow to scroll through the menu. Highlight RESOLUTION then press the central ENTER button. This brings up the resolution screen, shown in Figure 12 in its percentage mode. If the gas concentration is low it will show in parts per million, ppm.
- 7v) Use the central and right-hand buttons labelled + and – to adjust the Resolution. The percentage options are increments of: 0.05%, 0.01% or 0.001% of the span. The parts per million options are increments of 5 ppm, 1 ppm or 0.1 ppm.

### 3.1.11 Default values

The default values option allows the settings to be returned to the standard factory settings.

From the SETUP menu (see Figure 7) using the down arrow button **▼** to highlight the LOAD DEFAULTS option. The button options at the base of the screen change to BACK, LOAD and **▶**. Pressing the LOAD button will return the settings to the default factory values, which are:-

- Alarm High limit: 95%
- Alarm High idle polarity: LED ON
- Alarm Low limit: 5%
- Alarm Low idle polarity: LED ON
- LCD contrast: 14

Once set, the above values are stored in flash memory and will be used on start up.

*Procedure 8: Returning the unit to factory default settings*

- 8i) While in the VALUE mode (shown in Figure 4, the default mode after switch on) press the right-hand navigator button – the SETUP button.
- 8ii) This brings up the menu as shown in Figure 5.
- 8iii) Press the right-hand navigator button to access the menu.
- 8iv) Use the right-hand button labelled with an arrow to scroll through the menu. Highlight the LOAD DEFAULTS option then press the central ENTER button.
- 8v) Use the central LOAD button to load the factory set defaults.

### 3.1.12 Graph Display

When in VALUE or SETUP modes pressing the GRAPH button (the left-hand navigation button) will change the mode to the GRAPH mode (See Figure 15 below).

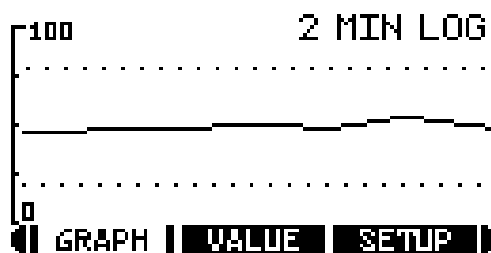

Figure 15: Graph Screen

In GRAPH mode the screen is used to display a graphical representation of the historical value of the indicated gas concentration. The way the data is presented may be changed by using the GRAPH mode setup menu described below.

While in GRAPH mode pressing the GRAPH button (the left-hand navigation button) again will open the GRAPH mode setup menu display (as shown below in Figure 16)

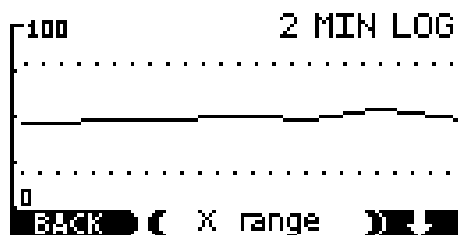

Figure 16: Graph settings menu.

Using the down arrow key you can move through the three options “X range”, “Y range” and “style”.

When “X range” is selected pressing the “X range” button displays the currently selected number of samples per pixel along with + and – button options. By pressing the appropriate + or – button the time axis may be changed between:

- 1 sample per pixel ( Graph displays last 16 seconds of readings)
- 4 samples per pixel ( Graph displays last 1minute of readings)
- 8 samples per pixel ( Graph displays last 2 minutes of readings)
- 80 samples per pixel (Graph displays last 21 minutes of readings)
- 480 samples per pixel (Graph displays last 2 hours of readings)

When “Y range” is selected pressing the “Y range” button the currently selected Maximum value displayed on the x axis is shown as a % of the monitor full scale along with + and – button options.

The scale of the “Y” (concentration) axis may be increased or decreased by pressing the appropriate + or – button.

Available scales are:

- 0-100% of full scale
- 0-10% of full scale
- 0-1 % of full scale

When “style” is selected pressing the “style” button again shows the currently selected style is displayed along with + and – button options.

Pressing the + or – buttons scrolls through the available options.

Available Graph styles are:

- Dots
- Lines (joined dots)
- Filled everything below the measurement line is filled (black).

The required option is selected by pressing the BACK button while it is displayed.

The display may be returned to the top level menu by pressing the BACK key, repeatedly if necessary.

### 3.2 Analogue Output

The analogue output is a current source and may be used to connect to external indication, control or data logging devices. The output can be configured to provide a 4-20 mA linear, 0-20 mA linear output using the options bit switch on the main PCB.

The analogue output is accessed by removing the terminal cover and is located on the left side of the case see Figure 1 above and Figure 17 below. The terminals are from left to right output and zero volts (labelled O/P and 0V respectively in Figure 17).



Figure 17: Analogue Output Terminals.

The output has two settings 4-20 mA and 0-20 mA. The options for these settings are shown in Table 3.2:

	Output Setting	
	4-20 mA	0-20 mA
Zero Reading	4 mA	0 mA
Span Reading	20 mA	20 mA
Max over-range	25.5 mA	22 mA
Max Under-range	3 mA	NA
Fault Condition	0 mA	25.5 mA

Table 3.2: Analogue output options

The output over-ranges (with reduced accuracy) up to 25.5 mA (4-20 mA) or 22 mA (0-20 mA). The guaranteed output drive capability is 11V giving a recommended maximum load of 430  $\Omega$  for full analogue output functionality. A 500  $\Omega$  load may be used to achieve a 0-10 V output; however the 11V limit means the fault indication on

the 0-20mA setting (25.5 mA) is not available. Under open circuit conditions the output may rise to 12.5 V maximum.

The current loop output mode is set by bit switch 5 on the main PCB to either 4-20mA (default) or 0-20mA (see Figure 18 below).

In the Guardian NGDC switches 1 to 4 have no function and must be left in the off position.

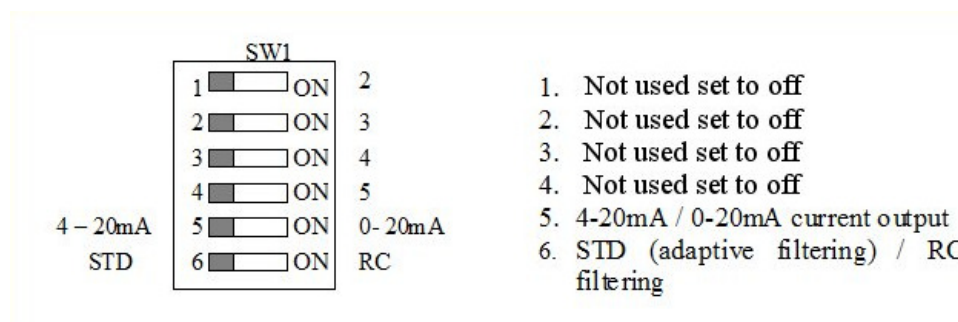

Figure 18: Bit switch

### 3.3 Power-On Self Test Sequence

When power is connected to the Guardian NGDC, it performs a self-test and warm-up sequence as follows:

Time	Display	Alarm Lights	Buzzer	Alarm Relays	Fault Relay	Analogue out (mA)	Analogue out (V)
0-10 seconds	Blank	Off	Off	Off	Off	undefined	undefined
10-20 seconds	Starting...	Dependent on gas concentration and alarm set points	Off	Dependent on gas concentration and alarm set points	energised	Settling towards gas reading	Settling towards gas reading
20+	Gas Reading	Dependent on gas concentration and alarm set points	Off	Dependent on gas concentration and alarm set points	energised	Equivalent to the gas reading	Equivalent to the gas reading

Table 3.3: Guardian NGDC self-test and warm-up sequence.

**Note:** the fault relay is energised in the non-alarming state so that it goes into the alarming condition when power is removed from the equipment (fail-safe operation). The fault relay can therefore be heard to operate and go into a non-alarming state when power is first applied.

### 3.4 Relay Outputs

The alarm and fault relays may be connected to external control or annunciation equipment. The relay outputs are suitable for direct connection to the standard single-phase mains supply since the relays used have a 5 kV coil/contact isolation and the PCB track clearances exceed 6mm.

Relays are generally designed either for power or low level signal switching applications. The contact requirements for these two applications are different and are generally incompatible. The Guardian NGDC however has been designed for use in either application. The relay contacts are made from a gold-plated silver-based alloy, which makes them suitable for either low level switching or high power switching applications. However, if the relays are used in power switching applications, they should not subsequently be used to switch low level signals as arcing may have damaged the gold plating.

The relay contacts are designed to switch the following resistive loads:

mains power switching	8A @ 250 VAC maximum
DC power switching	8A @ 30 VDC maximum

Table 3.4: Relay contact switching loads

For other voltages, the following limits should be observed:

maximum switching voltage	260 VAC, 150 VDC
maximum carrying current	8 A at 250VAC, 8A at 30VDC
maximum switching current	8 A

Table 3.5: Voltage limits

Life expectancy (normally 100,000 operations) of the relays will be reduced if used to switch inductive loads.

### 3.5 DC Power Supply

The Power supply in the Guardian NGDC accepts input voltages between 18 and 30 VDC. This should be compatible with most 50 W DC supplies encountered.



## Maintenance &amp; Service

## 4 Maintenance & Service

It is recommended that preventative maintenance is performed annually; this requires approximately fifteen minutes. More frequent maintenance may be required when the monitor is operated in demanding environments. Preventative maintenance comprises a calibration check (see *Procedure 16*) and replacement of the particle filter (see *Procedure 9*).

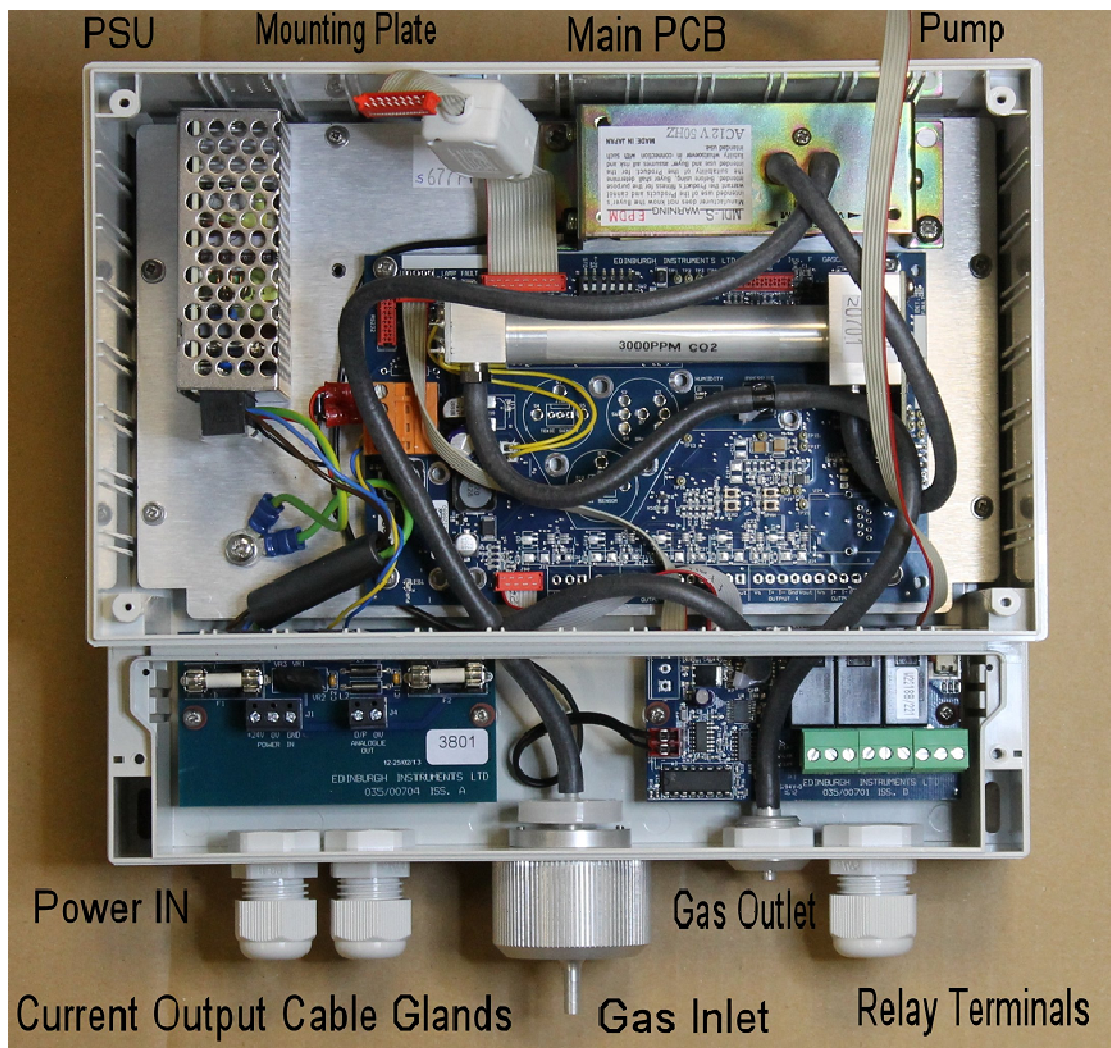

Figure 19: Guardian NGDC Internal View

## 4.1 Filter Replacement

### *Procedure 9: Replacing the filter*

- 9 i) Unscrew the knurled gas inlet/filter housing (Shown in Figure 19) to access to the particle filter capsule
- 9 ii) Remove the used filter capsule (twist and pull) and replace it with a new capsule, then re-fit the filter housing.

A spare filter capsule including integral seal is provided with each monitor. Further replacements can be purchased from your supplier quoting part number 99000, capsules without integral seals must not be used.

## 4.2 Opening the Guardian NGDC

### *Procedure 10: Opening the Guardian NGDC enclosure:*

- 10i) Switch off and isolate the mains supply to the instrument, including supplies associated with the relay outputs.
- 10ii) Remove the Terminal Cover by removing the two retaining screws and disconnecting the sounder from the Relay PCB by unplugging it.
- 10iii) Remove the screw covers in the corners of the front panel to reveal the retaining screws.
- 10iv) Remove the four screws which secure the front display/control panel (retain screws for refitting). Lift away the front panel by gently pulling on the sides. The electronics behind the front panel are connected to the main PCB by ribbon cables.
- 10v) Detach the two ribbon cables from the front panel PCB.

### **WARNING**

**Do not operate the unit without a filter as this may cause permanent damage to the sensor.**

## 4.3 Removing the Mounting Plate

Removal of the front panel allows access to the other PCB's sufficient to perform most service operations (primary fuse replacement, pump replacement, secondary filter replacement). For more major repairs, it may be necessary to remove the main mounting plate (see Figure 19).

### WARNING

**This monitor operates from a low voltage DC supply (between 18 and 30 VDC). But the Fault and Alarm Relays may be connected to mains power. Take care to avoid electric shock.**

#### *Procedure 11: Removing the mounting plate*

- 11i) Check that all power supplies are switched off and isolated. Remove the terminal compartment cover and disconnect all connections to the terminal blocks (taking note of connections for re-fitting later).
- 11ii) Disconnect the connections between the DC power PCB and the PSU (taking note of connections for re-fitting later).
- 11iii) Disconnect the two neoprene pipes between the PCB and the enclosure (gas inlet to pump and flow sensor to exhaust).
- 11iv) Disconnect the ribbon cables from the main PCB to the relay PCB by pulling the connector from their sockets.
- 11v) Disconnect the pump from the relay PCB by unplugging the connector from the relay PCB.
- 11vi) Remove the 5 screws around the edge of the mounting plate (retain screws and washer for refitting). Slide the mounting plate out by lifting out the top edge first.

To refit, reverse the above procedure. Ensure all connections are correct and secure before re-powering the instrument.

The Guardian NGDC has been designed to the highest safety standards, and the danger of coming into contact with the live conductors in normal use is minimal. However, we do not recommend that the unit be operated outside its case with the relays connected to mains power.

## 4.4 Fuse Replacement

### *Procedure 12: Replacing the fuse*

There are three fuses in the Guardian NGDC; one is located on the main PCB (see Figure 19) and two on the Power supply PCB. When replacing the power supply PCB fuses, use only 20 mm, anti-surge fuses (indicated by the character T before or after the fuse rating). Other faster fuses may blow during switch-on. Fuse details

Reference	Function	Rating
F1/F2	Power Terminal Board (see Figure 19)	2 A T
F1	Main PCB	1.5 A (can be reset)

Table 4.1 Fuse details

## 4.5 Pump Replacement

The pump is located on the Mounting Plate (Figure 19) and may be replaced as follows:

### *Procedure 13: Replacing the pump*

- 13i) Disconnect the pump from the relay PCB by unplugging the connector from the relay PCB.
- 13ii) Detach the pump by removing the two screws at opposing corners of the pump bracket which hold the pump to the PCB. The screws fit into inserts which are permanently attached to the mounting plate.
- 13iii) Withdraw pump and transfer neoprene pipes to the new pump (inlet and outlet are marked on pump by arrow heads ◀ VACUUM [inlet], PRESSURE ▶ [outlet], the outlet should be connected to the sensor head). Reverse steps 2 and 1 to complete the replacement.

## 4.6 Cleaning

### *Procedure 14: Cleaning the monitor*

- 14i) The exterior of the case may be cleaned using a soft cloth moistened in water to remove smudges and dust.
- 14ii) For more persistent marks, a soft cloth moistened in isopropyl alcohol may be used.
- 14iii) The use of more aggressive solvents or abrasive cleaners is not recommended.

---

## Calibration

### 5 Calibration

The Guardian NGDC is inherently stable and will maintain its calibration over extended periods with minimal maintenance. In normal use, the calibration should be checked every 12 months. Any adjustment should be small.

#### 5.1 Calibration Gas Accuracy

In order to check or adjust the calibration of the Guardian NGDC, you must supply gas of a known composition to the instrument. The accuracy of the gas used governs the accuracy of the calibration. Factory calibrations are performed with gas analysed to  $\pm 2\%$  of value with a K value of 2, which is the highest standard available commercially. For gas mixtures supplied in small disposable canisters, the best available analysis is  $\pm 5\%$ . Lower grades are available (up to  $\pm 20\%$  accuracy) at lower cost; we recommend that the best available analysed gas mixtures are used for all calibration operations.

#### **WARNING**

**Never connect gas cylinders (even with regulators) or other pressurised gas sources directly to the instrument, as the pressure may damage the monitor.**

#### 5.2 Connecting Calibration Gas to the Guardian NGDC

*Procedure 15: Connecting calibration gas to the Guardian NGDC.*

- 15 i) To connect gas to the Guardian NGDC, supply the gas to the instrument via a pipe with a T-Piece and a one metre pipe running off and venting to atmosphere. (See Figure 20)  
This prevents overpressure being applied to the unit and allows the pump in the Guardian NGDC to draw in the required gas flow with the excess venting off. The one metre line is necessary to prevent back flow of air into the system.
- 15 ii) Make sure that there is a positive outflow at the vent pipe either manually (with a wet finger) or with a flow meter.

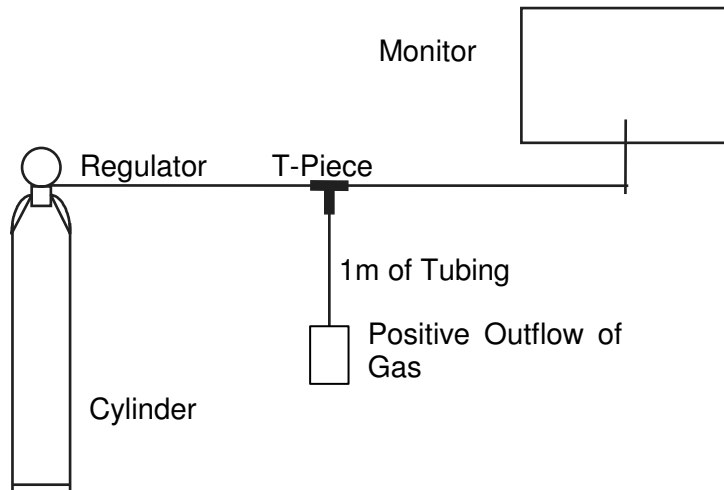

Figure 20: Connecting the calibration gas to the Guardian NGDC

## 5.3 Effects of Pressure on Calibration

Because gases are compressible, there are various ways of expressing the gas concentration (volume percent, partial pressure, density, mole density). Infrared gas analysers operate by measuring the amount of infrared energy absorbed by the gas and this is fundamentally related to the mole density (the number of molecules in the beam path).

Most users calibrate their equipment using gas mixtures supplied in cylinders which fundamentally provide constant volume percent mixtures. The relationship between mole density and volume percent depends on the ambient pressure and temperature. If a non pressure compensated infra-red monitor is checked periodically against a cylinder of calibration gas, the reading would appear to change, with the error being related to the pressure and temperature. The Guardian NGDC measures the pressure and temperature in the sensor head and compensates to eliminate these factors, so there are no systematic errors arising from variations in pressure and temperature over the range 0-40 °C and absolute pressure range 800 to 1150 hPa.

## 5.4 Calibration Checking Procedure

Before performing a calibration, read the above section on the effects of pressure on calibration and ensure that the sensor head pressure and temperature are within the permitted limits.

*Procedure 16: Checking the calibration:*

- 16 i) Power the Guardian NGDC for at least one hour before checking the calibration.
- 16 ii) Apply zero gas i.e. gas containing none of the gas measured by the instrument (nitrogen recommended) to the inlet port (see section 5.2 above) and allow the display to settle for at least one minute. The Instruments reading should be within the range  $0 \pm 0.5\%$  of the unit's full scale under normal conditions. If the zero display is outside this range you should adjust the zero calibration (see section 5.5.)
- 16 iii) Apply a certified Test Gas mixture containing a known, near span concentration (We recommend using gas with between 80% and 100% of the instrument full scale).
- 16 iv) Allow the display to settle for at least one minute. If the instrument's reading is different from the Test Gas concentration by more than  $\pm 2\%$  of its full scale  $\pm$  certified tolerance of Test Gas the unit should be recalibrated at zero and span (see section 5.5 below).
- 16 v) Remove the Test Gas to complete the procedure and return to normal operation.

## 5.5 Calibration Procedure (see also 3.1.1)

Before performing a calibration, read the above section on the effects of pressure on calibration and ensure that the sensor head pressure and temperature are within the permitted limits.

The Zero and Span adjustment buttons are located on the front panel and may be accessed using the display menu system. The value of the zero and span adjustment variables are stored in the microprocessor flash memory. The values of the zero and span adjustment variables are set to mid-position during factory calibration to allow maximum field adjustment. It also enables any field adjustment and its extent to be checked on return to the factory.

---

# Calibration

## *Procedure 17: Calibrating the Guardian NGDC*

- 17 i) Power the Guardian NGDC for at least one hour before checking the calibration.
- 17 ii) Apply zero gas i.e. gas containing none of the gas measured by the instrument (nitrogen recommended) to the inlet port (see section above) and allow the display to settle for at least one minute. If the instrument's zero reading is out of specification it may be adjusted by enabling the zero + and - adjustment buttons (press the VALUE button when in value mode see section 3.1.1) Once the buttons are enabled they may be used to set the displayed value to zero.
- 17 iii) Apply a certified Test Gas mixture containing a known, near span concentration (We recommend using gas with between 80% and 100% of the instrument full scale).
- 17 iv) Allow the display to settle for at least one minute. If the instrument's reading is out of specification it may be adjusted by enabling the span + and - adjustment buttons (press the VALUE button when in value mode see section 3.1.1) Once the buttons are enabled they may be used to set the displayed value to be the same as the certified value of the Test Gas being used.
- 17 v) Remove the Test Gas supply and exit the calibration mode by pressing the BACK button to end the calibration procedure and return the unit to normal operation.



## Trouble Shooting

### 6 Trouble Shooting

Servicing should only be performed by a qualified electronics engineer.

#### WARNING

**This apparatus operates from a low voltage DC supply (between 18 and 30 VDC). However, the Fault and Alarm Relays may be connected to mains power. Take care to avoid electric shock.**

#### 6.1 Errors & fault indications from the firmware

The Guardian continually monitors various parameters and in the event of a malfunction, it will operate the fault relay, the warning buzzer and the fault light on the front panel. All navigation switches are disabled and the display will show an error code which is explained in the table below.

Error #	Description	How to fix it
1	Lamp Fault	<ul style="list-style-type: none"> <li>- Change Lamp</li> <li>- Check Lamp voltage</li> </ul>
2	Negative Reading Fault (Indicated Concentration less than - 5% )	<ul style="list-style-type: none"> <li>- Check the detector</li> <li>- Recalibrate</li> </ul>
3	Over range Fault (Indicated Concentration more than 130% of FSD )	<ul style="list-style-type: none"> <li>- Check the detector and gas</li> <li>- Recalibrate</li> </ul>
4	DSP temperature > 70C	<ul style="list-style-type: none"> <li>- Make sure the ambient temperature is within specifications</li> <li>- Use cooling if necessary</li> </ul>
5	DSP temperature < 0C	<ul style="list-style-type: none"> <li>- Make sure the ambient temperature is within specification limits</li> </ul>
6	Head temperature > 70C	<ul style="list-style-type: none"> <li>- Make sure the ambient temperature and the gas temperature are within specifications</li> <li>- Use cooling if necessary</li> </ul>
7	Head temperature < 0C	<ul style="list-style-type: none"> <li>- Make sure the ambient temperature and the gas temperature are within specifications.</li> </ul>
8	Reference signal under 50% of nominal	<ul style="list-style-type: none"> <li>- Damaged Optics</li> <li>- Check signal and gains.</li> </ul>

9	Channel signal under 10% of nominal	<ul style="list-style-type: none"> <li>- Damaged Optics</li> <li>- Check signal and gains.</li> </ul>
10	Sample channel too close to Zero value during Span Calibration	<ul style="list-style-type: none"> <li>- Span Calibration Failed</li> <li>- Restart the board and re calibrate (Zero gas first)</li> </ul>
11	Sum of coefficients not equal to 1	Check stored coefficient values
12	Flow fault	Check the pump and pipe work for blockages or faults

Table 6.1: Troubleshooting, problems and solutions.

---

## Safety & System Integrity

### 7 Safety & System Integrity

Gas vented from the Guardian NGDC monitor is usually released in to the surroundings. If this presents a hazard, particularly to personal safety, the gas should be vented safely by attaching suitable tubing to the outlet nozzle - see section 2.3.

Components of the sampled gas, including those not measured by the Guardian NGDC, should be assessed for toxicity, flammability, risk of explosion and asphyxiation as well as any hazards specific to the installation (biological, nuclear, etc.). The gases which can be measured by the Guardian NGDC present the following hazards:

Gas	Gas	Hazard	Limit
Carbon Dioxide	CO <sub>2</sub>	Asphyxiant	0.5% (8 Hour Exposure Limit)
Methane	CH <sub>4</sub>	Explosive	5% (Lower Explosive Limit In Air)

Table 7.1 Gas Hazards

The Guardian NGDC performs continuous self-checking. If a fault is detected, the audible alarm sounds and the fault is indicated on the front display panel. In addition the fault relay is depowered and the analogue outputs are forced into a state dependant on the bit switch options, so that external equipment can detect the fault and take the appropriate action. See section 2.2. for further details. If the Guardian NGDC is used with external equipment to provide a control or alarm function, the user should ensure that the equipment and wiring make use of the fault annunciation facility so that the system responds appropriately to a fault condition. Catastrophic faults in the Guardian NGDC may mean that a fault is not indicated, this should be considered by the user in the system design.

## 7.1 Toxic Gases

Where gas sensors or gas monitor equipment is used with atmospheres which contain asphyxiant, toxic or explosive gas components, it is the responsibility of the user/installation engineer to investigate and to execute all appropriate measures necessary to eliminate the risks to health resulting from the use of this equipment, or resulting from a leak or fault created within or through the use of the equipment.

Gas	Gas	Hazard	Limit
Carbon Dioxide	CO <sub>2</sub>	Asphyxiant	0.5% (8 Hour Exposure Limit) Concentrations of 10% (100,000 ppm) or more can produce unconsciousness or death
Methane	CH <sub>4</sub>	Explosive	5% (Lower Explosive Limit In Air)
Carbon Monoxide	CO	Toxic	Lethal at 1% (8 Hour Exposure Limit 50ppm), (Short Term Exposure Limit 300ppm).

Table 7.2: Gas toxicity.

---

# Specification

## 8 Specification

---

<p><b>Ranges:</b>  <b>CO<sub>2</sub></b>            0-3000 ppm to 0-100%  <b>CH<sub>4</sub></b> <sup>2</sup>            0-5% to 0-100%</p> <p><b>Accuracy:</b> <sup>1</sup> &lt; ±2% of full scale  <b>Response Time:</b> T<sub>90</sub> &lt; 30s from sample inlet  <b>Operating Temperature Range:</b> 0-40°C  <b>Atmospheric Pressure:</b>            800-1150hPa</p> <p><b>Warm-up Time:</b></p> <table border="0"> <tr> <td>Operational</td> <td>1 min</td> </tr> <tr> <td>Full Specification</td> <td>30 mins</td> </tr> </table> <p><b>Humidity Range:</b> Unaffected by 0-95%  RH (non condensing)</p> <p><b>Power Supply:</b>  18 to 30 VDC</p> <p><b>Power Consumption:</b> 13 W typical</p>	Operational	1 min	Full Specification	30 mins	<p><b>Alarm Ranges:</b> zero to full scale</p> <p><b>Controls: via display and menu</b>  alarm 1 view and adjust  alarm 2 view and adjust  zero adjust  span adjust  options bit switch</p> <p><b>Outputs:</b>  4-20 mA/0-20 mA analogue output  11V guaranteed drive capability  Alarm 1 relay, Alarm 2 relay &amp; Fault relay  SPCO (single pole change-over)  voltage free contacts rating:  8A at 250 VAC (resistive load)  8A at 24 VDC (resistive load)</p> <p><b>Enclosure rating:</b> IP54  <b>Dimensions :</b> 260 x 280 x 140 mm  <b>Weight:</b> 2.5 kg</p>
Operational	1 min				
Full Specification	30 mins				

---

Table 8.1: Specifications

**NOTES:**

1. Accuracy does not include calibration gas accuracy.
2. This equipment is not-suitable for use in/with explosive atmospheres.
3. Precautions must be taken where there is a risk of asphyxiation (see section 7.1).
4. This equipment is specified for use in air and air like backgrounds.

---

## Glossary

### 9 Glossary

Acronym	Definition
AC	Alternating Current.
BS	British Standard.
CH <sub>4</sub>	Methane.
CO <sub>2</sub>	Carbon Dioxide.
CO	Carbon Monoxide.
COSHH	Control of Substances Hazardous to Health.
DC	Direct Current
DSP	Digital Signal processor
EMC	Electromagnetic Compatibility
EN	European Standard.
FSD	Full Scale Deflection.
IEC	International Electrotechnical Commission.
LCD	Liquid Crystal Display.
LED	Light Emitting Diode.
NDIR	Non-dispersive Infrared.
PCB	Printed Circuit Board.
ppm	Parts per million.
PSU	Power Supply Unit.
PVC	Polyvinyl Chloride
RH	Relative Humidity.
RMA	Returned Materials Authorisation.
VAC	Volts Alternating Current.
VDC	Volts Direct Current.

---

## Index

### 10 Index

'memory' effect .....	4	molecules.....	24
ALARM.....	7, 8, 9	navigation buttons .....	5, 7, 11
analogue output.....	1, 3, 5, 16, 31	particle filter.....	1, 19
calibration.....	5, 6, 19, 23-26, 31	password .....	7, 10, 11
condensation .....	4	PCB .....	16, 17, 19-22, 32
electrical installation .....	2	pump.....	1, 21-23, 28
gas concentration .	6-10, 13, 14, 17, 24	relays .....	2, 5, 17, 18
GRAPH .....	14	resolution .....	12, 13
IDLE POLARITY.....	9	sampling .....	1, 3, 4, 5
LCD SETTINGS .....	7, 10	SETUP mode.....	7
maintenance.....	1, 19, 23	terminal cover .....	16
mole density .....	24	VALUE mode .....	5, 7- 11, 13

---

## Accessories and Spare Parts

### 11 Accessories and Spare Parts

<b>Part Number</b>	<b>Description</b>
99000	Particle Filter With Integral Seal
S95023	Replacement Pump



---

## Warranty

### 12 Warranty

Edinburgh Instruments Ltd is an ISO9001:2000 registered company, your Guardian NGDC has been manufactured in accordance with our quality system. The product should only be operated in accordance with this manual and other documentation supplied by the manufacturer.

Edinburgh Instruments Ltd guarantees the equipment against defective materials or workmanship for a period of one year from the date of delivery. Exceptional operating conditions, damage due to careless handling, modifications made by the owner or misapplication will void the guarantee.

In no event shall Edinburgh Instruments Ltd be liable for any consequential loss or damage arising from the failure of the equipment under warranty. At the end of the warranty period, all liability for failure of the equipment shall be absolutely at an end.

In the event of a fault occurring with the Guardian NGDC the equipment should be returned to the authorised dealer from whom it was originally purchased. For equipment being returned directly to Edinburgh Instruments Ltd, please contact our Sales Department for an RMA number (Returned Materials Authorisation) which will ensure that your equipment is dealt with promptly by our service department. All shipments must be pre-paid, properly packed, insured and clearly labelled with the RMA number.

**NOTE:**

*If the equipment to be returned has been in contact or used with a substance hazardous to health (covered by COSHH regulation), Edinburgh Instruments Ltd must be notified in advance as this could constitute a health risk/hazard to our personnel.*

---

## CE Mark Details



### 13 CE Mark Details

The Guardian NGDC unit has been CE marked to indicate compliance with all essential requirements of the Directives referenced.

2014/30/EU	Conforms to the essential requirements of the Electromagnetic Compatibility Directive and its amending directives.
------------	--

The Guardian NGDC is intended for use in commercial and light industrial environments and the following standards have therefore been applied:

BS EN 50270:20015	EMC immunity for residential, commercial and light-industrial environments
BS EN 61000-6-3:2007 +A1:2011	EMC emission standard for residential, commercial and light-industrial environments
BS EN 61010-1:2010	Safety requirements for electrical equipment for measurement, control and laboratory use

---

**Document Change History**

## 14 Document Change History

<b>ECN</b>	<b>DATE</b>	<b>ISSUE</b>
Original	September 2013	1 v09/13
7293	May 2014	1 v05/14
7456	May 2016	1 v05/16
7463	June 2016	1 v06/16

## Appendix A

### Guardian NG Mounting Drawing

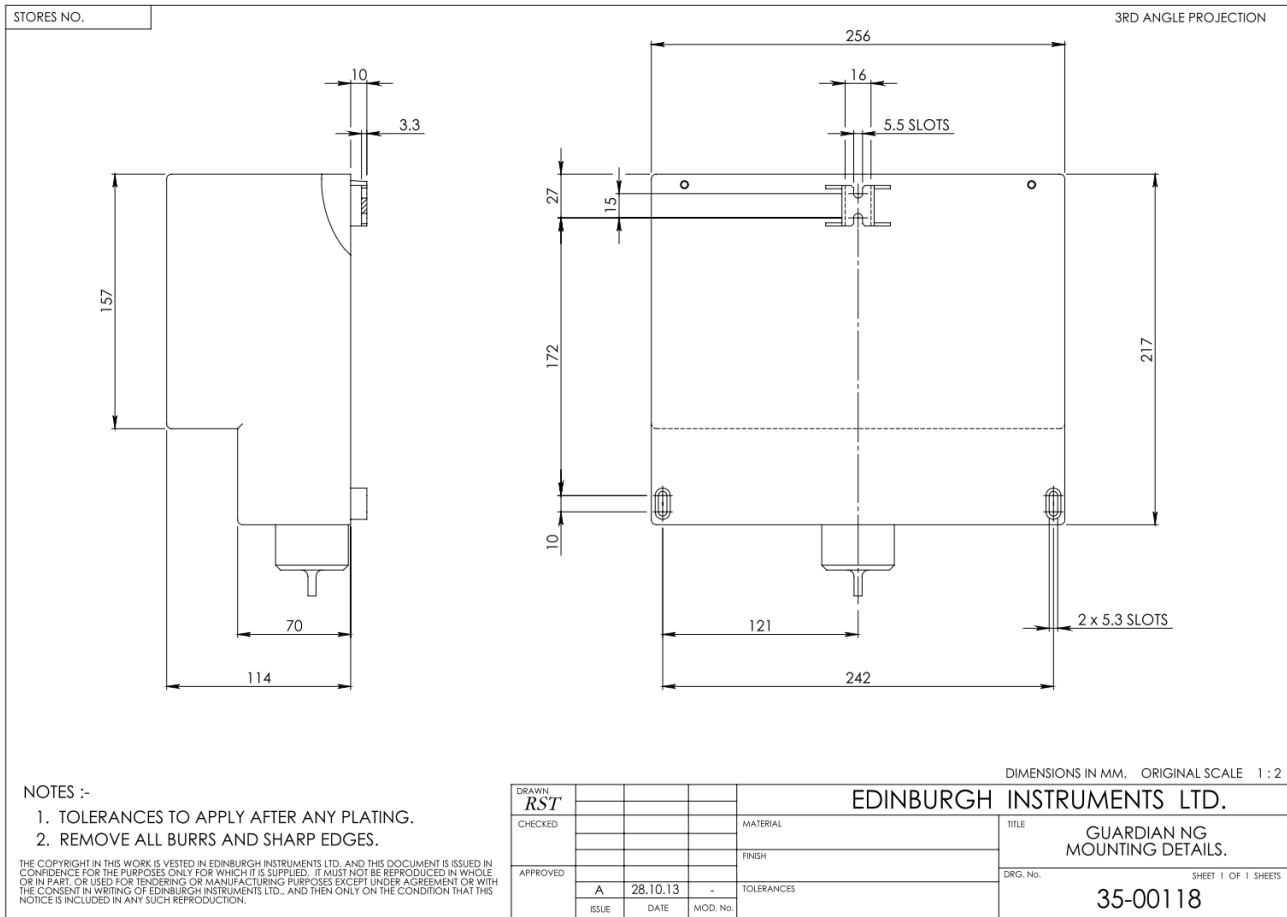

## Appendix B

*York* **EMC Services Ltd**

**EMC TEST CERTIFICATE**  
 YORK EMC SERVICES (2007) Ltd  
 DONIBRISTLE INDUSTRIAL PARK  
 DUNFERMLINE FIFE KY11 9HZ  
 TEL: 01383 825057  
 FAX: 01383 825396  
 UKAS Testing Number 1574

<b>Issued to: -</b>	Edinburgh Instruments Ltd 2 Bain Square Kirkton Campus Livingston EH54 7DQ	<b>Order Nos.</b>	0000160985, 0000161363
---------------------	--	-------------------	------------------------

<b>Electromagnetic Compatibility Test/s were performed on the apparatus as detailed: -</b>			
<b>Description</b>	Guardian NG Gas Sensor		
<b>Type number</b>	None		
<b>Serial Number/s</b>	None		
<b>Configuration/ Mode of Operation</b>	The EUT was powered from a 230V 50Hz mains supply		
<b>Date received</b>	7 <sup>th</sup> February 2011	<b>Date Tested</b>	7 <sup>th</sup> February to 16 <sup>th</sup> March 2011
<b>Specification/s</b>	EN50270: 2006	Electromagnetic Compatibility (EMC) Electrical apparatus for the detection and measurement of combustible gases, toxic gases or oxygen Tested at Type 1 levels	

The apparatus to which this certificate relates was tested against the above specifications. Full results are retained on file at the EMC Test Centre, Donibristle. The apparatus was found to be compliant to the above specifications subject to the following conditions:

**UKAS Accreditation**

Tests marked "Not UKAS Accredited" in this certificate are not included in the UKAS Accreditation Schedule for our laboratory. Opinions and interpretations expressed herein are outside the scope of UKAS Accreditation.

**EUT Submitted**

These results apply only to the particular EUT submitted, in the configuration used and in the mode of operation tested.

<b>Certificate No: -</b>	3127TC1	<b>Job No: -</b>	17219/2, 17310/1 & 17297	<b>Date: -</b>	25 <sup>th</sup> March 2011	<b>Page 1 of 2</b>
<b>PDF copy</b>	X					

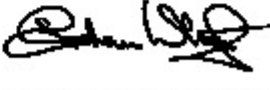
<b>Tested by: -</b>	 C. Hamilton Test Technician	<b>Approved signatory: -</b>	 G. Whyte Laboratory Manager / Senior Engineer, TMJET
---------------------	--	------------------------------	---

The Copyright in this certificate is vested in York EMC Services (2007) Ltd. The Certificate may be reproduced in its entirety but reproduction of any extract is expressly forbidden.

EMC FORM 044 Issue 12



A BIS designated  
Notified Body  
No 1892  
Consultancy



York EMC Services (2007) Ltd  
THE UNIVERSITY of York  
Hoskings  
York  
YO19 8DD  
UK

Tel: +44 (0) 1904 434449  
Fax: +44 (0) 1904 424424  
Email: enquiries@yorkemc.co.uk  
www.yorkemc.co.uk

Registered in England and Wales  
Company Reg No. 6580583  
VAT Reg No. GB 417 2054 41